

Combinazioni Moduli

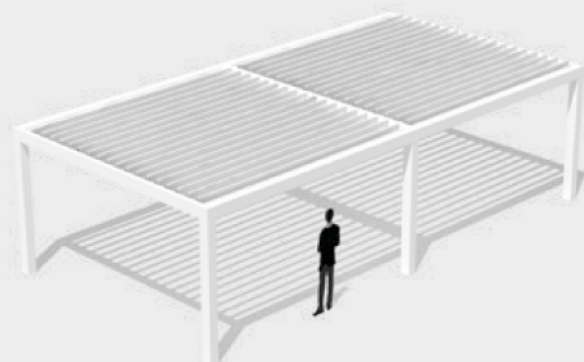

Modulo Singolo a Isola



Modulo Accoppiato a Isola

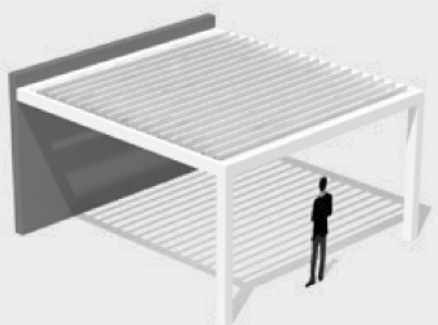

**Modulo Singolo Addossato
Lato Larghezza**

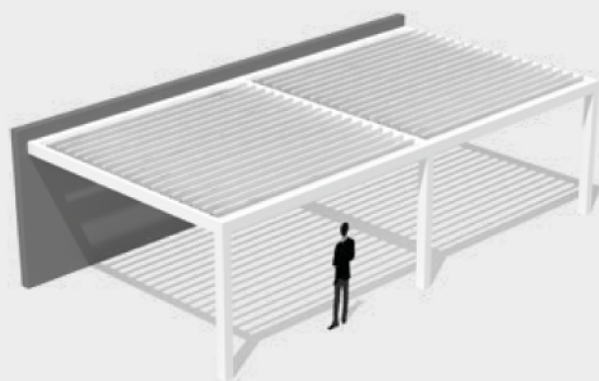

**Modulo Accoppiato e Addossato
lato Larghezza**

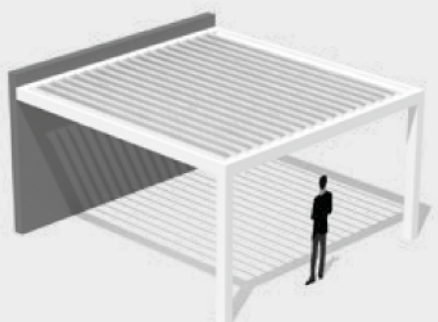

**Modulo Singolo Addossato
Lato Sporgenza**

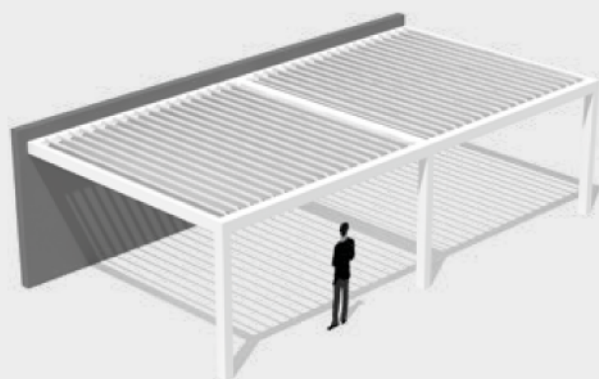

**Modulo Accoppiato e Addossato
Lato Sporgenza**

Caratteristiche Modulo

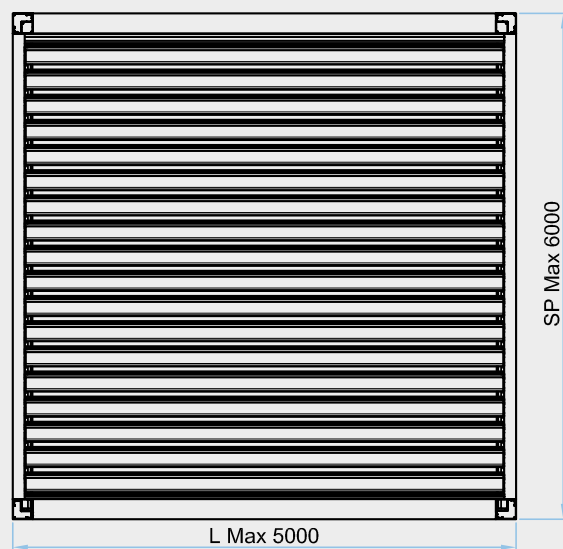
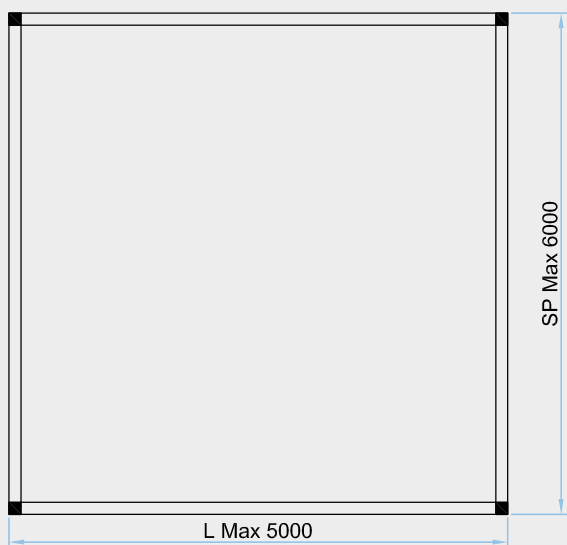
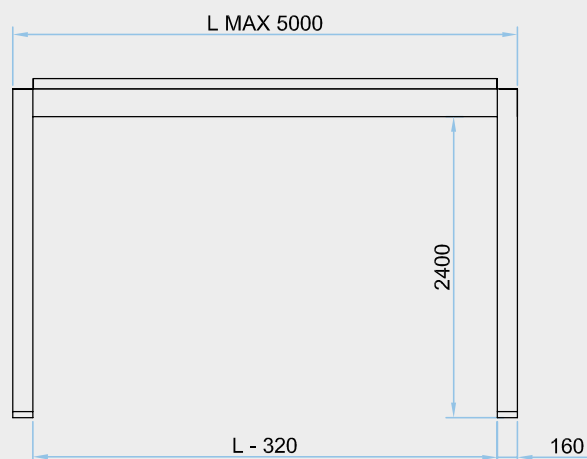
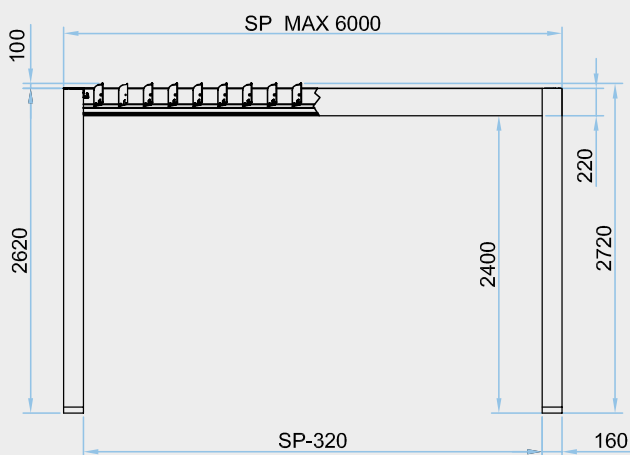

Legenda

L Larghezza misurata ai lati esterni dei montanti.

SP Sporgenza misurata ai lati esterni dei montanti.